

# PNEUMATRON

www.pneumatron.co.za

sales01@pneumatron.co.za

## PVTX2XXW Series

### ELECTRIC TIMER BALL VALVE - 2/2 Way Stainless Steel

#### SPECIFICATIONS:

Media: Compatible media with Stainless Steel, PTFE & EPDM

Ambient temperature: -15 to 50 Deg C

Media temperature: 2 to 90 Deg C

Voltages: 9/24 VDC/AC or 110/230VAC

Lower Voltage applied, Lowers Speed of movement.

OFF time adjustable from 00:00:00 to 99:59:59S

ON time adjustable from 00:00:00 to 99:59:59S

Actuator Protection: IP62



1/4" (8mm), 1/2" (15mm), 3/4" (20mm) & 1" (25mm) close and open in +/- 6 seconds

Port & Orifice Size	Pressure Range	Wiring Diagram	Body
1/2" BSP (15 mm)	0 to 10 Bar	W22 wiring	PVTX215W22DX
3/4" BSP (20 mm)	0 to 10 Bar		PVTX220W22DX
1" BSP (25 mm)	0 to 10 Bar		PVTX225W22DX

PVTX - PVTX=Normally/Fail Closed, PVTX=Normally/Fail Open, PVTX=Detend (Depends on wiring)

DX - Describes voltage (D1=AC110-220V, D2=AC/DC9-24)

#### Wiring diagrams

##### W22 (2 Wire control - Spring return)

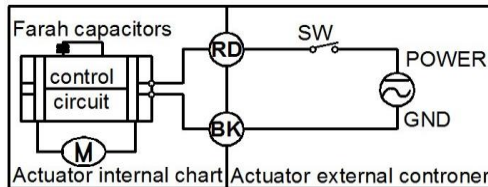

SW	- Switch
BL	- Blue
WT	- White
YW	- Yellow
RD	- Red
GR	- Green
BK	- Black
GY	- Gray

SW is closed, the valve opens. Actuator switches off automatically when ball valve is completely open.

SW is open, the valve closes. Actuator switches off automatically when ball valve is completely closed.

# PNEUMATRON

[www.pneumatron.co.za](http://www.pneumatron.co.za)

[sales01@pneumatron.co.za](mailto:sales01@pneumatron.co.za)

## Dimensions

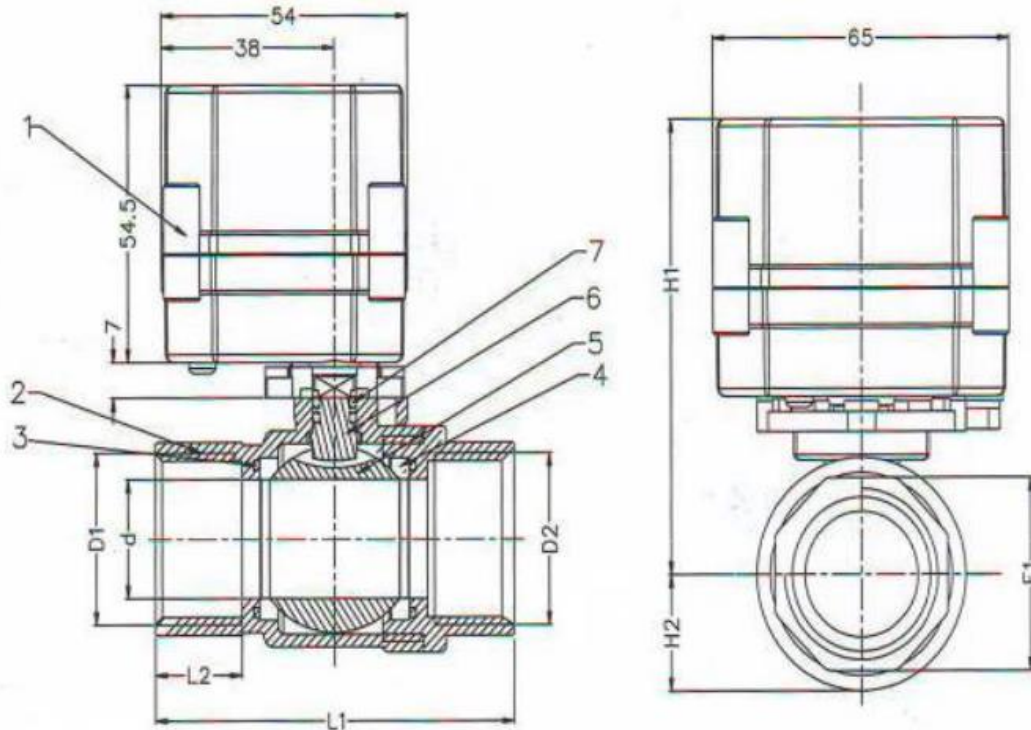

### **BODY DIMENSION CODE (Size in mm)**

Valve body	D1/D2	L1	L2	E1	H1	H2
PVTX215W22DX	1/2" (15mm)	63	14	25	83	17
PVTX220W22DX	3/4" (20mm)	72	17	31	87	20
PVTX225W22DX	1" (25mm)	81	18	38	95	24

# PNEUMATRON

www.pneumatron.co.za

sales01@pneumatron.co.za

## Timer Specifications

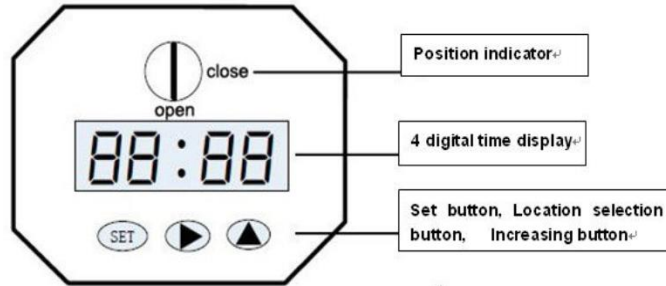

## Operation Instructions:

Actuator parameter setting has two menu structures:

- Function code (First Menu)
- Setting the parameters of the function code (Secondary Menu)

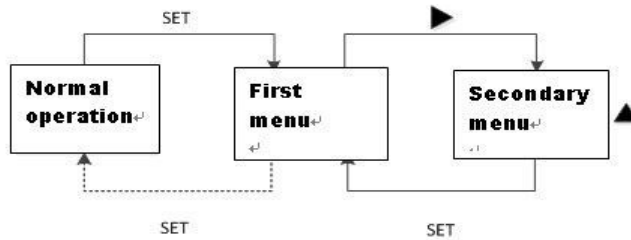

## Secondary menu operation menu

Function code	Content	Value	Unit	Remarks
t on	valve keeping open time	00:00:00 - 99:59:99	H:M:S	
toFF	valve keeping closed time	00:00:00 - 99:59:99	H:M:S	
PonS	Power-on Action	On/oFF		
Prot	Stall current setting	0-599	MA	When the current is bigger than the setting value 1.6s, the motor will stop working and the display will show Err.

# PNEUMATRON

www.pneumatron.co.za

sales01@pneumatron.co.za

## Parameter function control table

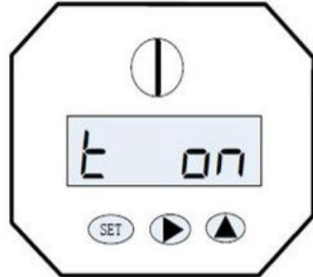

Picture 1

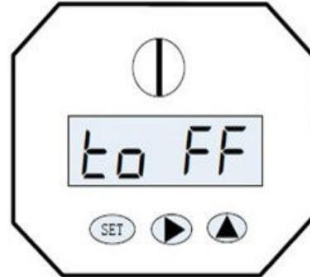

picture 2

1. Press **SET** for 2 seconds to enter First menu. In First menu the screen will display as in Picture 1 (t on), indicating enter to set the valve keeping open state

Press **SET** again, the screen will now display as in Picture 2 (toFF), indicating enter to set the valve keeping closed state.

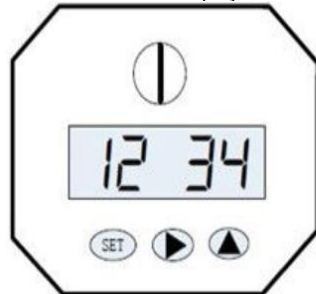

Picture 3



picture 4

2. Then press **▶** after entering the setting state, showing the valve keeping time for setting. (Set the valve keeping open time in the 't on' state and set the valve keeping closed state in the 'toFF' state).

Select flashing bit by pressing **▶** change numerical parts by pressing **▲**

When ':' is flashing, indicate setting "HS (hours):MS (minutes)", change the flashing bit by pressing **▶**

When the ':' is bright, indicate setting "MS (minutes):SS (seconds)". The data will be deposited in the valve controller after completing the setting.

Press **SET** when finish setting, will return to first menu, press **SET** again, enter to next first menu to set parameters.

# PNEUMATRON

www.pneumatron.co.za



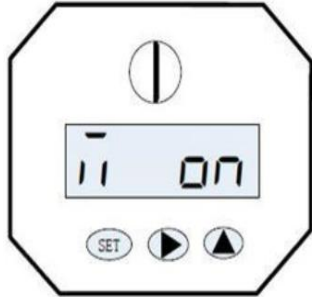



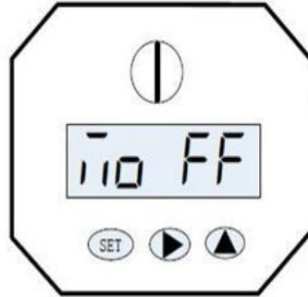

sales01@pneumatron.co.za



Picture 5



picture 6

3. Press  &  , the screen will display as in Picture 5, indicating open the valve manually.  
Press the  &  , the screen will display as in Picture 6, indicating close the valve manually.  
To exit manual mode press  &  or  & 



Picture 7



picture 8

4. In the normal working state, the displayed time is the valve keeping open or closed time. (e.g. Valve keeping open time is 10s, it will count down 10s)

The ':' is flashing, indicating the "HS (hours):MS (minutes)"

The ':' is bright, indicating the "MS (minutes):SS (seconds)"

## Stalling protection function

When the actuator detects stalling, it will run in reverse direction. When it reaches the position to open or close, it will do the open or close action again. Meanwhile displaying 0000-0001 flashing on the screen (indicating the current retrying times). When it fails at the third retrying, the valve will stop and display ERRL on the screen.